

Cassette Awning

WPC Awning 400



Contents

- 1 Product Introduction
- 2 Product Features
- 3 Motor
- 4 Autonomous Sensor
- 5 Tehoma Motors
- 6 Product Installation



A modern outdoor patio at dusk. The patio is covered by a large, light-colored awning with warm, recessed LED lighting along its edges. Several square tables with dark metal frames and woven chairs are arranged on the concrete patio. In the background, a large window looks out onto a garden with trees and a sunset sky. The overall atmosphere is warm and inviting.

#1

Product Introduction

WPC Awning 400

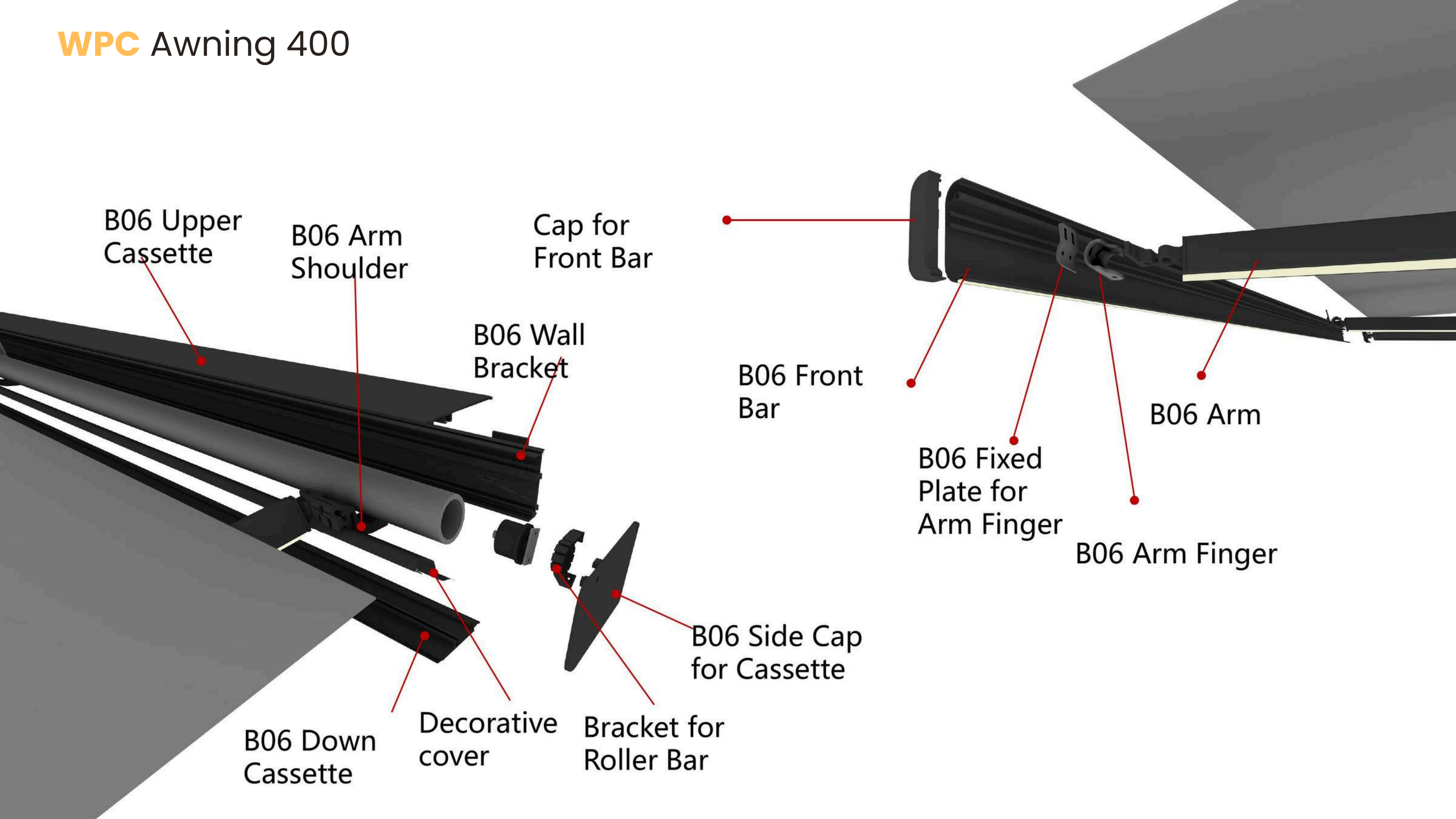

B06 Upper Cassette

B06 Arm Shoulder

Cap for Front Bar

B06 Wall Bracket

B06 Front Bar

B06 Fixed Plate for Arm Finger

B06 Arm

B06 Arm Finger







B06 Down Cassette

Decorative cover

Bracket for Roller Bar

B06 Side Cap for Cassette

WPC Awning 400

Photo	Profile Name	Size(MM)
	B06 Big Arm Profile B06 Small Arm Profile	79.5*39*2.8 73*33*2.2
	B06 Upper Tube for Cassette	209*3.3
	B06 Down Tube for Cassette	181.3*2.3
	B06 Front Tube	155*43.5*2.0
	B06 Back Tube for Cassette	160*56*7
	B06 Decorative Cover	147.2*28.3*2.2



WPC Awning 400



- Open State

Size range:

Extended size: 1.5-4 meters

Width size: 2.5-7 meters



- Close State

160mm



268mm

WPC Awning 400

#2

Product Features

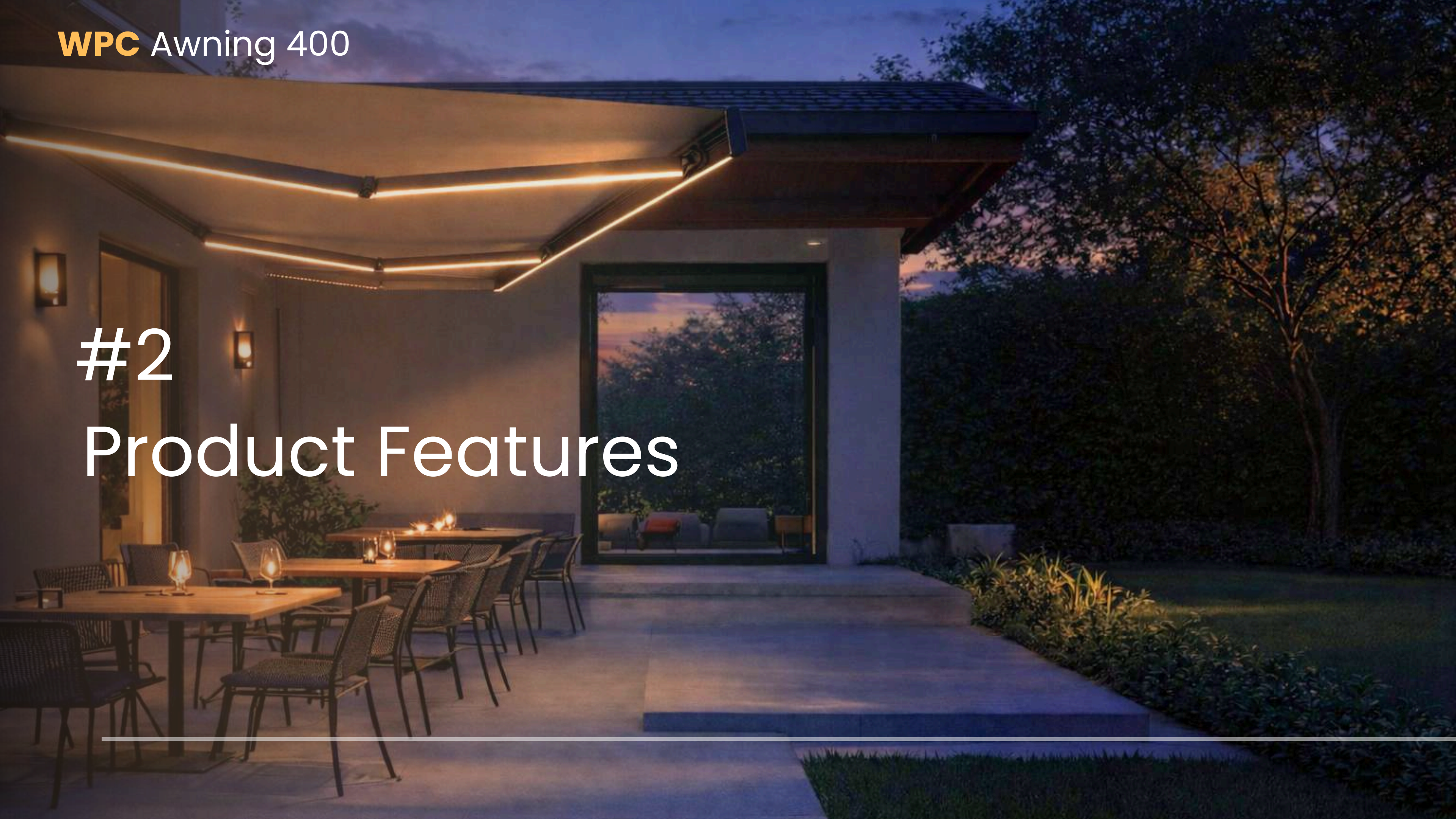

WPC Awning 400

- Minimalist Square Box Shape



- The awning with a minimalist square box design has a simple and elegant appearance and smooth lines. It is small and exquisite, does not take up space, and is the highlight of home decoration. The unique square shape highlights personal taste and makes life full of fun and vitality.



- Thickened chain, more stable arm tension strength
- The thickened chain design greatly improves the load-bearing capacity of the arm, and the tensile strength of the arm is more stable and reliable, ensuring the safety of the awning movement process and making it safer to use.

WPC Awning 400



- Arm with lights, built-in light cord
- Provides warm ambient light
- Optional RGB or dimming light strips, more options choices



- The front tube has a light design with built-in light lines. The extended front tube has a light design that fits the scene selection and meets the lighting needs at night.



WPC Awning 400

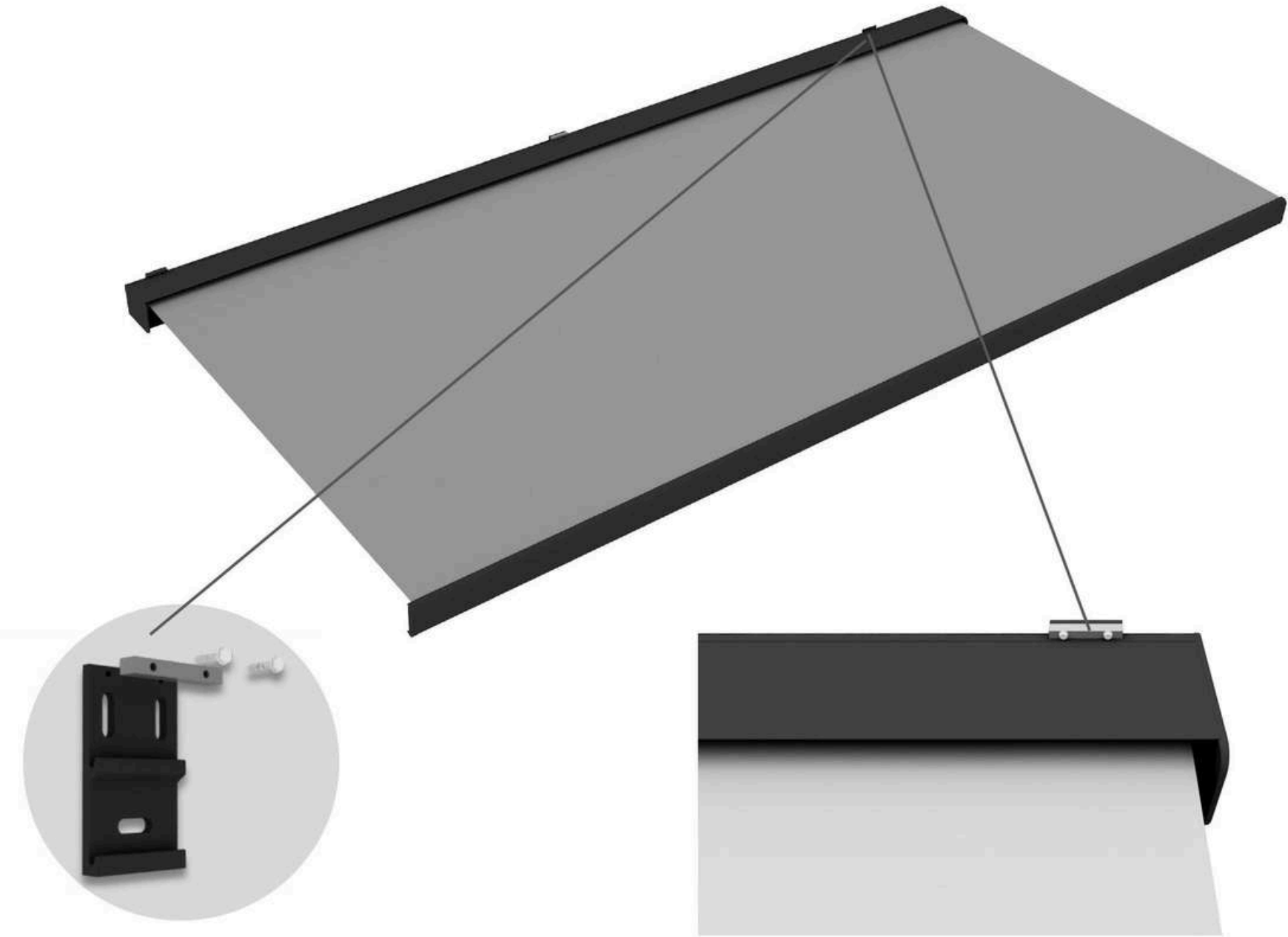

- Easy installation

Awning with strong wall bracket, it is convenient and quick to install against the wall, and equipped with anti-slip plate to enhance the force.

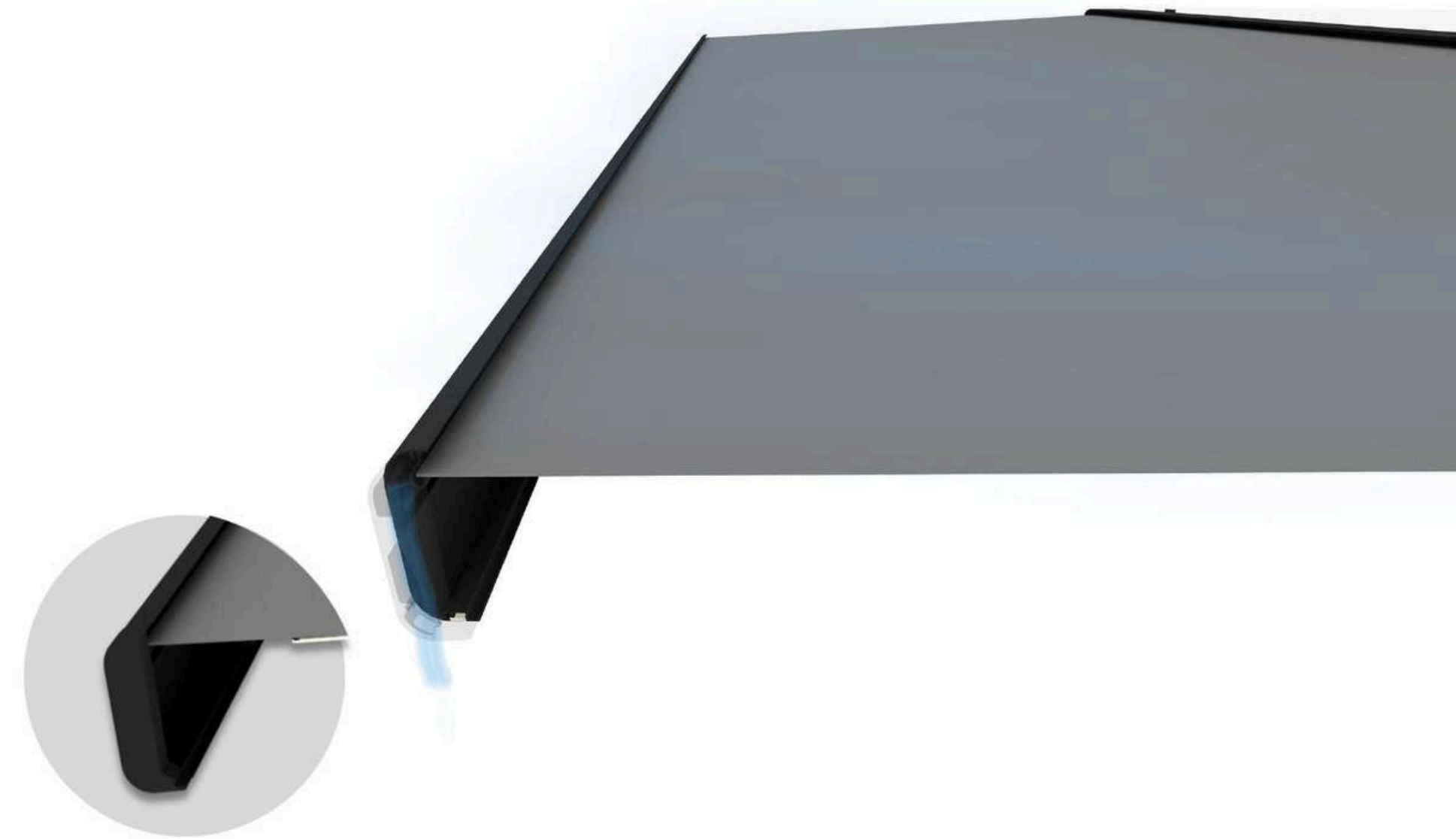

- Front tube with rain gutter

Drain holes are designed at both ends of the front pipe to facilitate drainage and prevent water accumulation, effectively preventing rainwater from backflowing and infiltrating.

WPC Awning 400

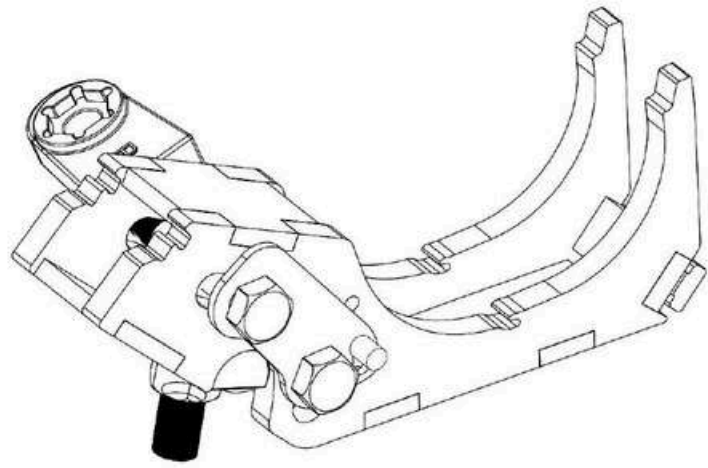

- The arm shoulder is with adjustable holes, which corresponds to the pitch angle of the crank arm in layers. After adjustment, tighten the bolts and insert the locking bolts into the holes to prevent loosening and deflection, and keep the tarpaulin at the preset angle.

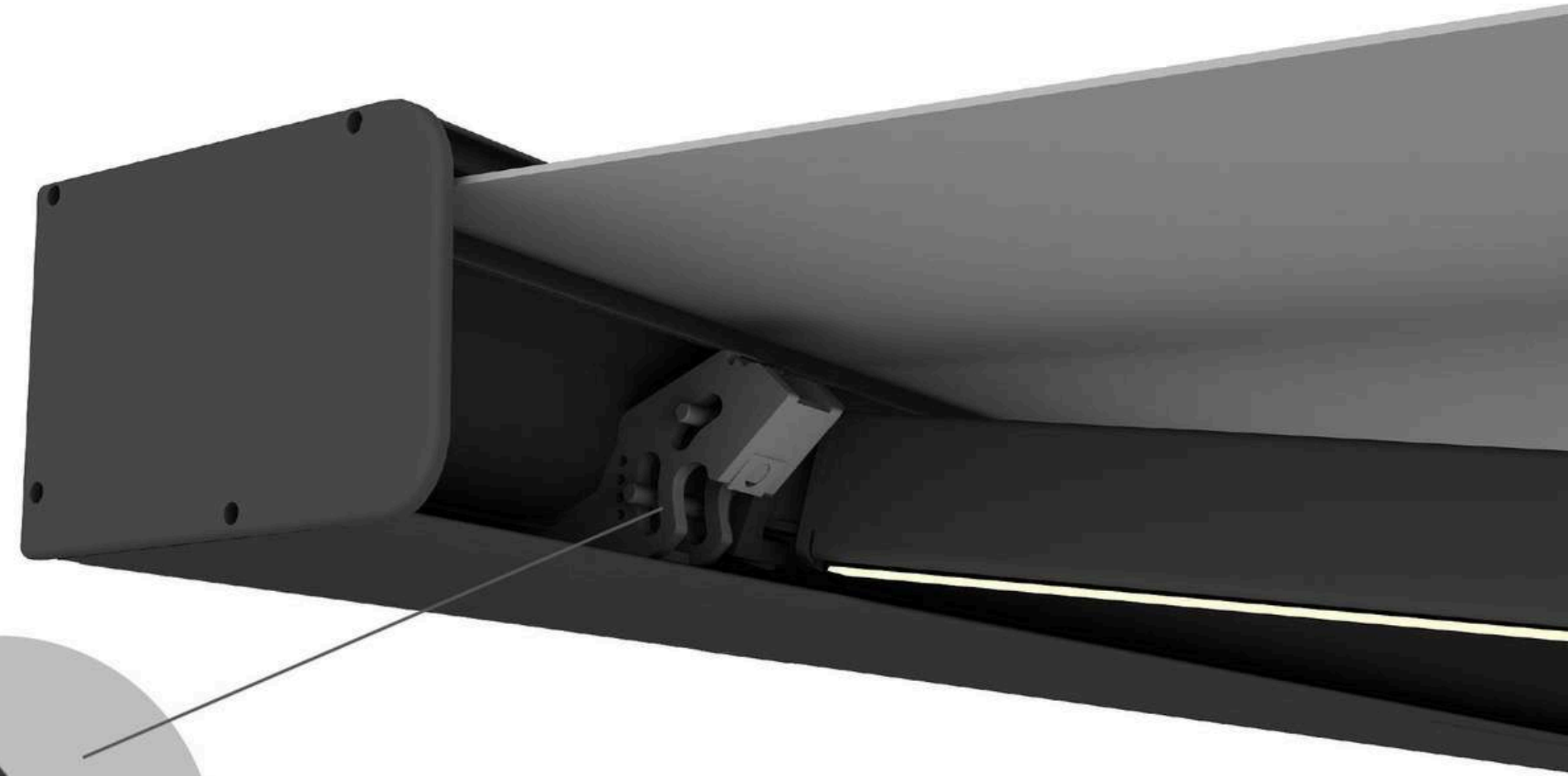

- High-strength arm adjustment seat
Equipped with an adjustable angle arm fixing seat, the arm can be adjusted in pitch. High-strength steel is used as the main material to ensure that the arm can be extended to four meters, with stronger wind resistance and more stable use.

WPC Awning 400

3
Motor

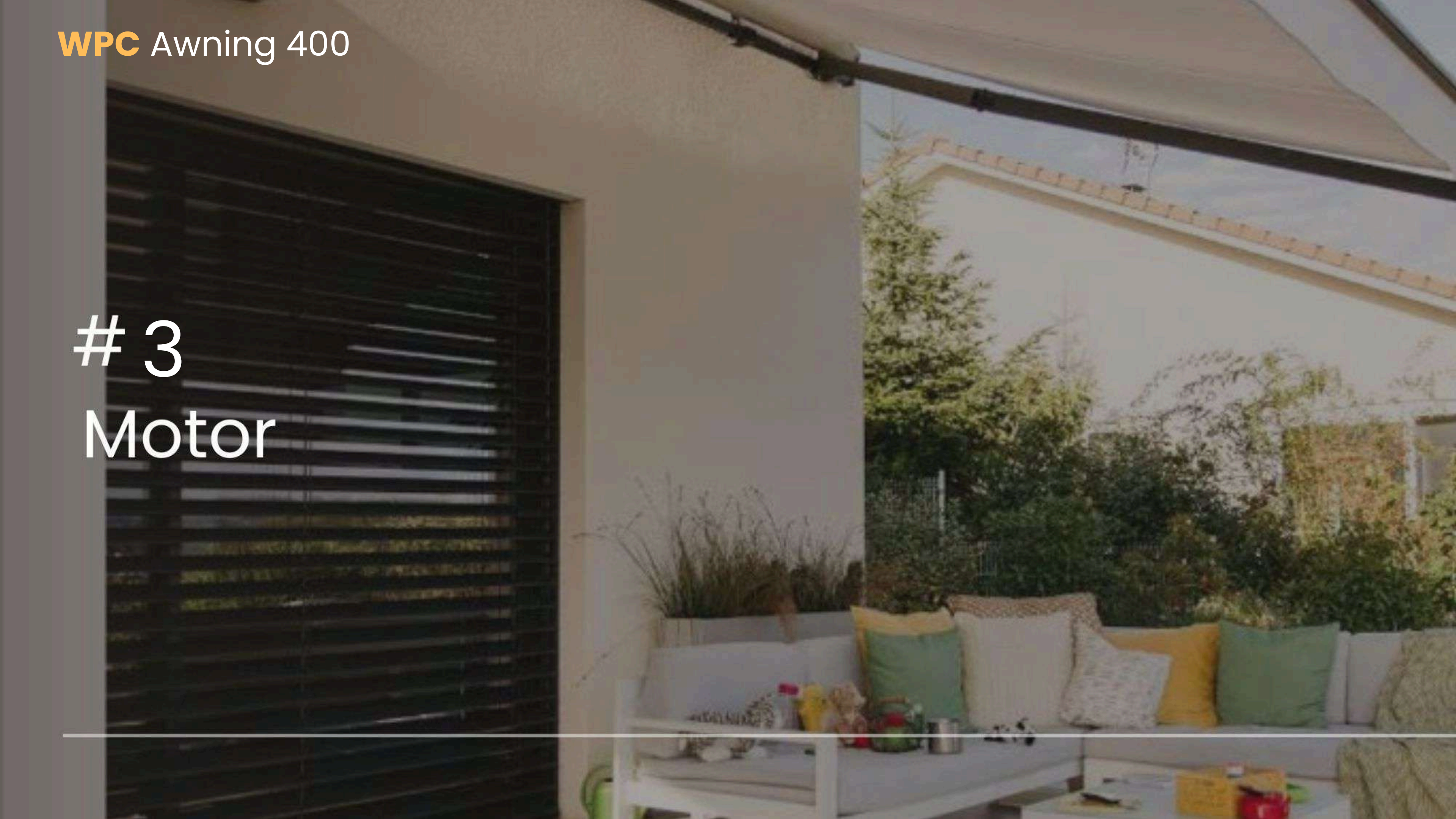





WPC Awning 400

Radio Motor Solution for Awnings By Somfy

Without Cassette

Sunilus io is a smart, radio-controlled motor designed especially for awnings and vertical screens without a cassette. It offers smooth operation, enhanced protection, and effortless daily comfort.

-  The motor features a star head with 6 different positioning options, allowing installers to adjust the motor head orientation easily for various awning configurations.
-  One click moves the awning to your favourite setting. Perfect shade every time, instantly
-  Remote limit setting
-  An electronic detection device stops the motor instantly if there is an obstacle during any motion

Aesthetics & Long-Term Durability

Sunilus io helps extend the life of your awning by supporting:

- Automated wind protection – retracts in strong winds
- Automated solar protection – shields your patio and interior from heat
- Lighting integration – create a relaxing evening ambiance

Smart, Centralized Control

Control your entire patio—awning, screens, and lighting—using a single remote control, combining comfort, style, and smart living.

somfy[®]
Make the move



WPC Awning 400

Power supply	230 V - 50 Hz
Index Protection Rating	IP 44
Thermal time	4 minutes
Number of wires of the cable	3
Wire section	0,75 mm ²
Type of limit switch unit	Electronic
Capacity of the LSU	Diameter 50: 241 turns Diameter 60: 184 turns
Repeatability	< ± 5°
Radio frequency	868-870 Mhz (tri band)
Capacity of memory	Maxi 9 for 1W transmitter - infinite for 2W transmitters
Antenna	Integrated
Range	20 m with 2 reinforced concrete walls to be passed through Possibility to enhance radio range thanks to a Repeater
Basic crown for tube Ø	50 diameter: 50 x 1,5 mm 60 diameter: 63 x 1,5 mm
Temperature working range	80% of life time between -10°C to +40°C 20% of life time between -20°C to +70°C

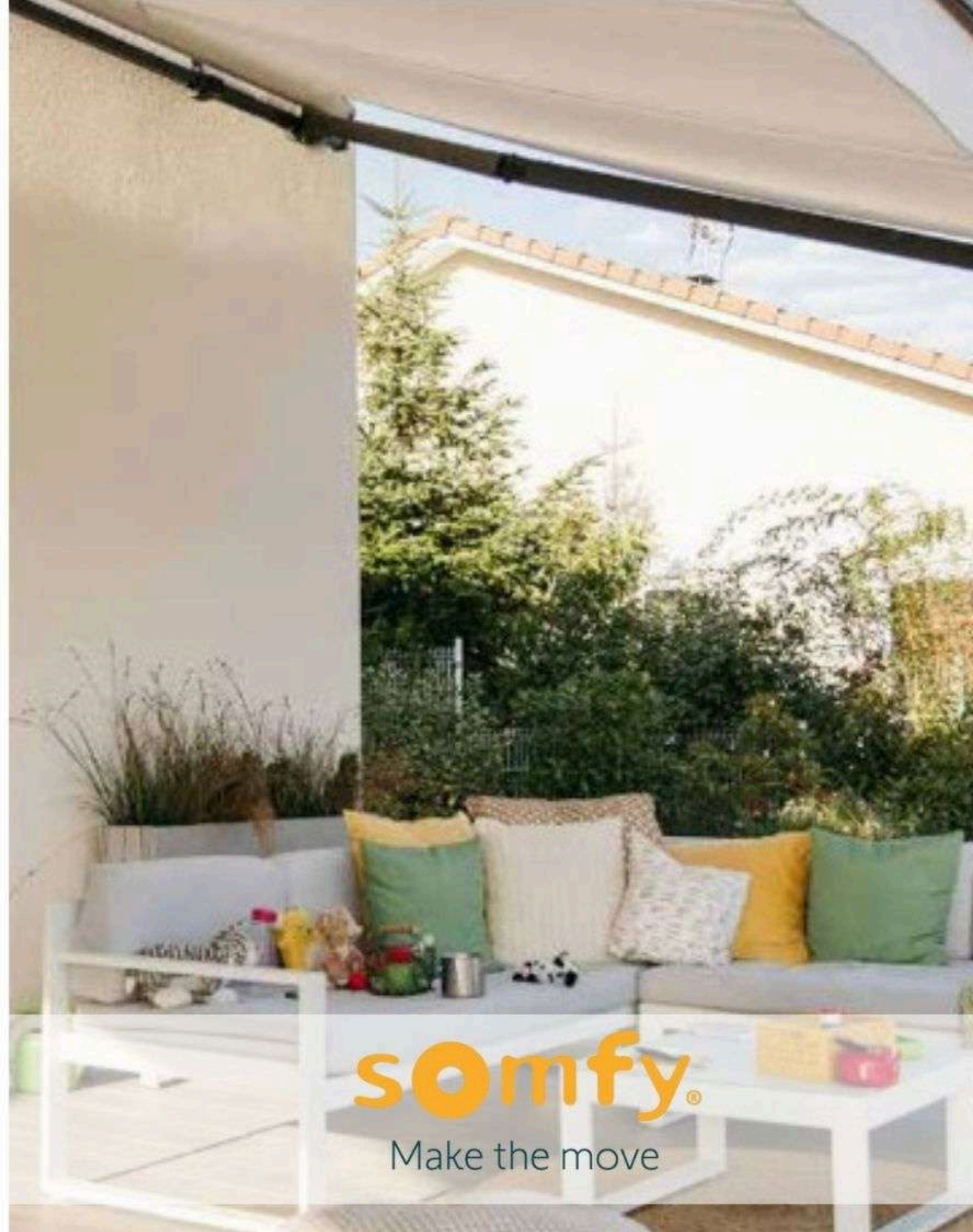

WPC Awning 400

	Torque(Nm)	Speed(rpm)	Diameter
Sunilus 50 io 20/17	20	17	50
Sunilus 50 io 25/17	25	17	50
Sunilus 50 io 30/17	30	17	50
Sunilus 50 io 35/17	35	17	50
Sunilus 50 io 40/17	40	17	50
Sunilus 50 io 50/12	50	12	50
Sunilus 60 io 55/17	55	17	60
Sunilus 60 io 70/17	70	17	60
Sunilus 60 io 85/17	85	17	60
Sunilus 60 io 100/12	100	12	60
Sunilus 60 io 120/12	120	12	60



somfy[®]
Make the move

WPC Awning 400

An all-in-one io-homecontrol® awning motor with advanced features, compatible with all awning types—both cassette and non-cassette—offering full bi-directional communication



Perfect closure

The guarantee that cassette closes every time.



Adjustable electronic Stop detection « Soft Close »

Once the cassette is closed, the motor stops immediately to protect the mechanism and limit stress on the fabric. Possibility to choose between 3 levels of closure power.



Adjustable back release

When activated, it releases the motor break just after the cassette closure, to relax the fabric. This extends the lifespan of the fabric.



Star head

6 options to position the motor head



“my” favourite

In one click move the blind to your favourite position



Electronic rail guided system control

Automatic rail guided system fabric length compensation, to guarantee constant projection, event after several years.



Rail guided system protection

An electronic detection device (crown stop) stops the motor instantly if there is an obstacle during any motion.



Remote limit setting

somfy®
Make the move

WPC Awning 400

#4

Autonomous Sensor

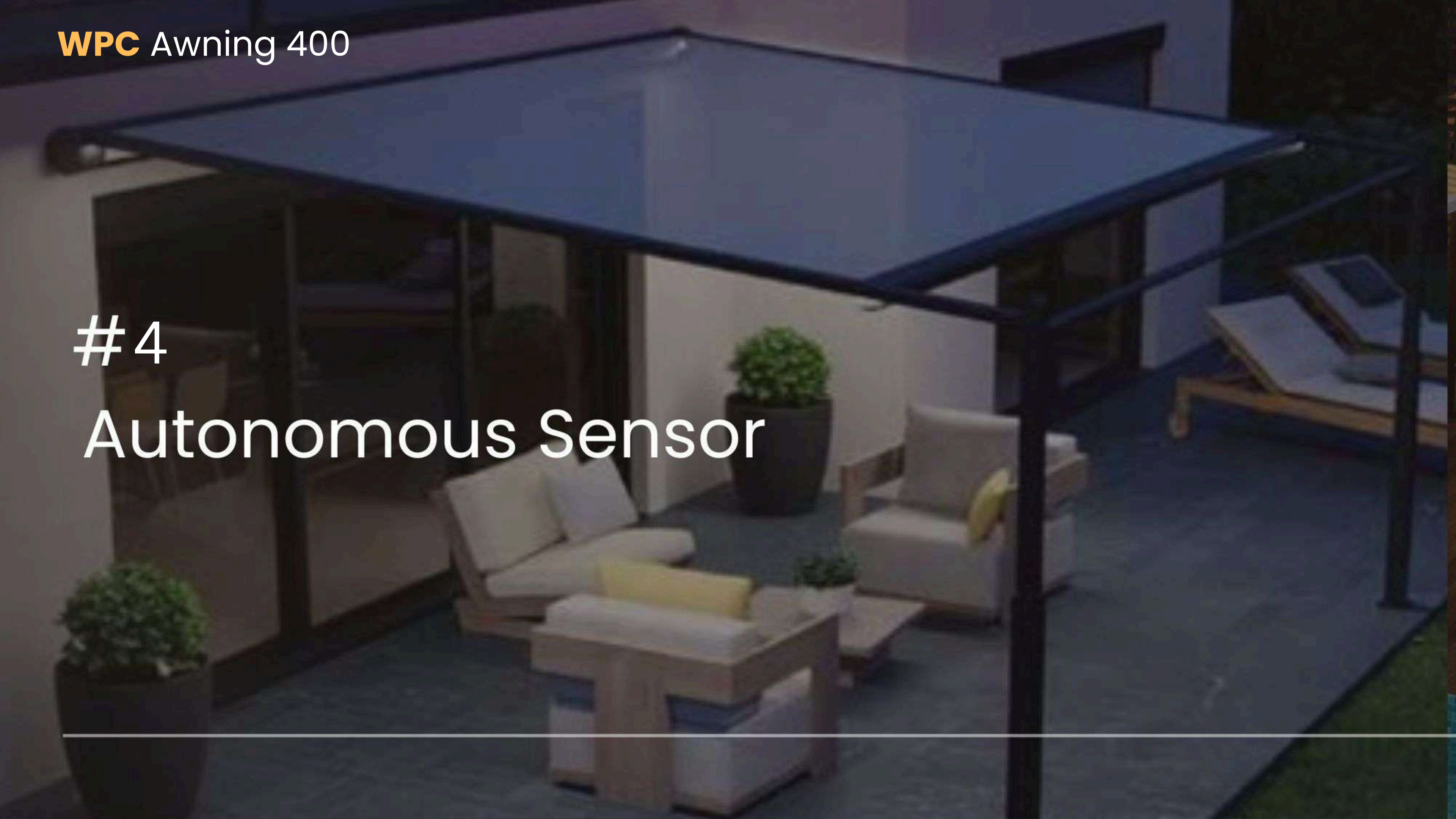

WPC Awning 400

EOLIS 3D WIREFREE RTS

autonomous sensor (cordless and with batteries). Its technology is based on a three dimensional acceleration sensor. This sensor is exclusively dedicated to Terrasse arm awnings (folding arm, semi cassette and cassette)

Temporisations	User mode	Demo Mode
wind appearance(acceleration)	12sec	12 sec
wind disappearance(stop of acceleration)	30 sec / 12 min	15 sec

The wind is declared present when counter of vibration pass over the threshold: - 4 times for each level 12 sec 15 sec At this moment, the awning goes up and lock the remote control and sensor orders (no possibilities to go down). Then disappearance of the vibration : - 30s after , the remote control orders are enable - 11mn30s after, the automatism (sun) orders are enable

somfy[®]
Make the move



Levels	0	1	2	3	4	5	6	7	8	9
Corresponding acceleration	*	0.15	0.225	0.3	0.375	0.45	0.525	0.6	0.675	0.75

WPC Awning 400

EOLIS 3D WIREFREE RTS

COMPATIBILITIES AT THE 10/08/06

Motors :-

OREA (230V/120V) diameter 50 / 60

- ALTUS (230V/120V) diameter 40 / 50 / 60

- LT RTS 2

- LT RTS CSI

Controls :

- Soliris sensor RTS -

Eolis sensor RTS

- Sunis sensor Wirefree RTS

Receivers :

- Universal receiver RTS

- Orienta Receiver RTS

- Soliris UNO RTS

somfy.

Make the move

TECHNICAL SPECIFICATIONS

Temporisations	User mode	Demo Mode
Box	Material,Color ,Size, Protection factor against solid and splash proof	ABS(UV stabilised) / PP
Battery	30 sec / 12 min	Bronzal Ultra light /BlackRAL / Alpine White 25 X 38 X 153 (h x l x L) IP 44
Battery lifetime (at ambient temperature)	Voltage Type	2x1.5V AAA Alkaline batterie
Radio characteristics (RTS Protocole):	Frequency Radiated power Modulation Type Range in free field	433.42 Mhz +/- 100kHz 6 dBm ASK Type A1 150 m
Standard		EN 60730 EN 301489-3 EN 300220-3
Temperature range	Storing Working	-30°C / + 80°C -20°C / + 60°C
Antenna		Built in
Electro Magnetic compatibility	CEI 1000-4-2 CEI 1000-4-3	8 kV lev III
CE Requirements		Yes
Weight		90g (including batteries)

WPC Awning 400

DESCRIPTION/DIMENSION

- 1) LID
- 2) Water evacuation holes
- 3) Waterproof joint
- 4) AAA Alkaline batteries
- 5) Potentiometer: - 0:Automatic setting - 1-9: predefined setting
- 6) Electronic circuit board + integrated radio antenna
- 7) Programming Button
- 8) Fixing support
- 9) ON/OFF magnet

Technical Characteristics
Power supply: 2 AAA alkaline batteries
Size: 25 x 38 x 153 mm (h x l x L)
Space between the oblong:
A= 93,5 mm B=120,5 mmm

somfy®

Make the move

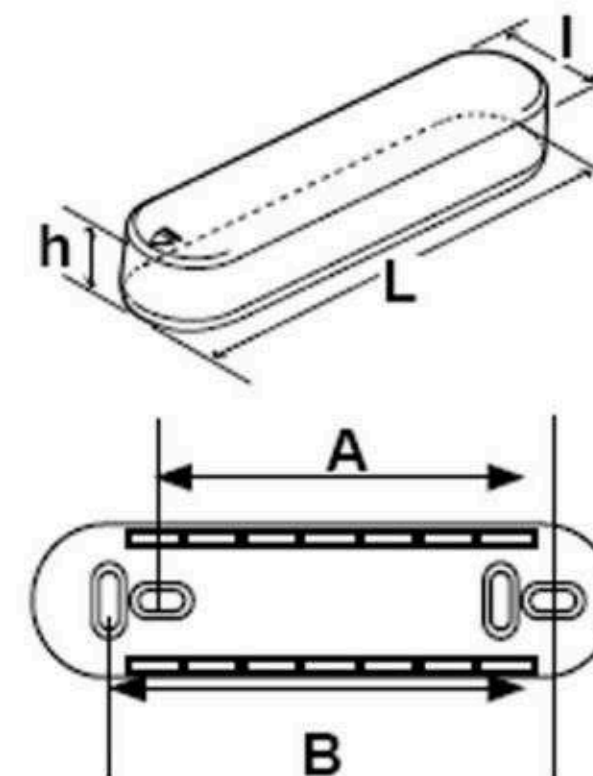

Eolis 3D Wirefree io

The Eolis 3D Wirefree io is part of the process Act for Green, it received the eco-design expertise to reduce its environmental impact.



1,17 kg CO₂ eq.
Global Warming*



18,5 MJ
Total use of primary energy*



1,13E-04 kg Sb eq.
Depletion of abiotic resources*



ELECTRONIC COMPONENTS

Microprocessors have been selected for their more recent technology and miniaturization, which requires less material and energy in their manufacturing process.



DURABILITY

The lifetime of the product is a fundamental of Somfy quality.



RAW MATERIALS

It has been proven that this product comply with RoHS and REACH regulations.



PACKAGING

Eco-design of this product packaging has promoted the use of recycled and recyclable materials. The instructions guides are made of 100% recycled paper.

WPC Awning 400

#5

Tehoma Motors



WPC Awning 400

TaHoma® Switch

The TaHoma® Switch is a smart control hub that allows you to centralize, automate, and customize your awning operation

Open and evolutive solution

- Compatible with Somfy and partner products as well as voice assistants.
- New products can be easily added with the TaHoma application.
- Scenes can be adapted with the buttons according to the customer's needs

Centralize and control the home in one touch

- Dedicated buttons to launch 2 favourite scenes.
- Customize scenes as much as desired

Designed for all desires





- Fully customizable
- Fits anywhere in the home, thanks to the Wi-Fi connection and its sobriety



somfy.
Make the move

WPC Awning 400

TaHoma® Switch

Specifications	Details
Compatible equipment	    
Requirements	Wi-Fi router with Internet access
Technical data	Power supply: 230V / 5V DC - 1A Wireless connection: Wi-Fi 802.11 802.11 b/g/n 2.4 GHz
Pack contents	TaHoma® switch Plug + Power-supply cable (1.5m)
Dimensions	162 x 67.5 x 34 mm
Weight	235 g

5

YEARS WARRANTY

Control buttons

App control

Compatible
Voice control*

somfy®

Make the move

WPC Awning 400

#6

Product Installation

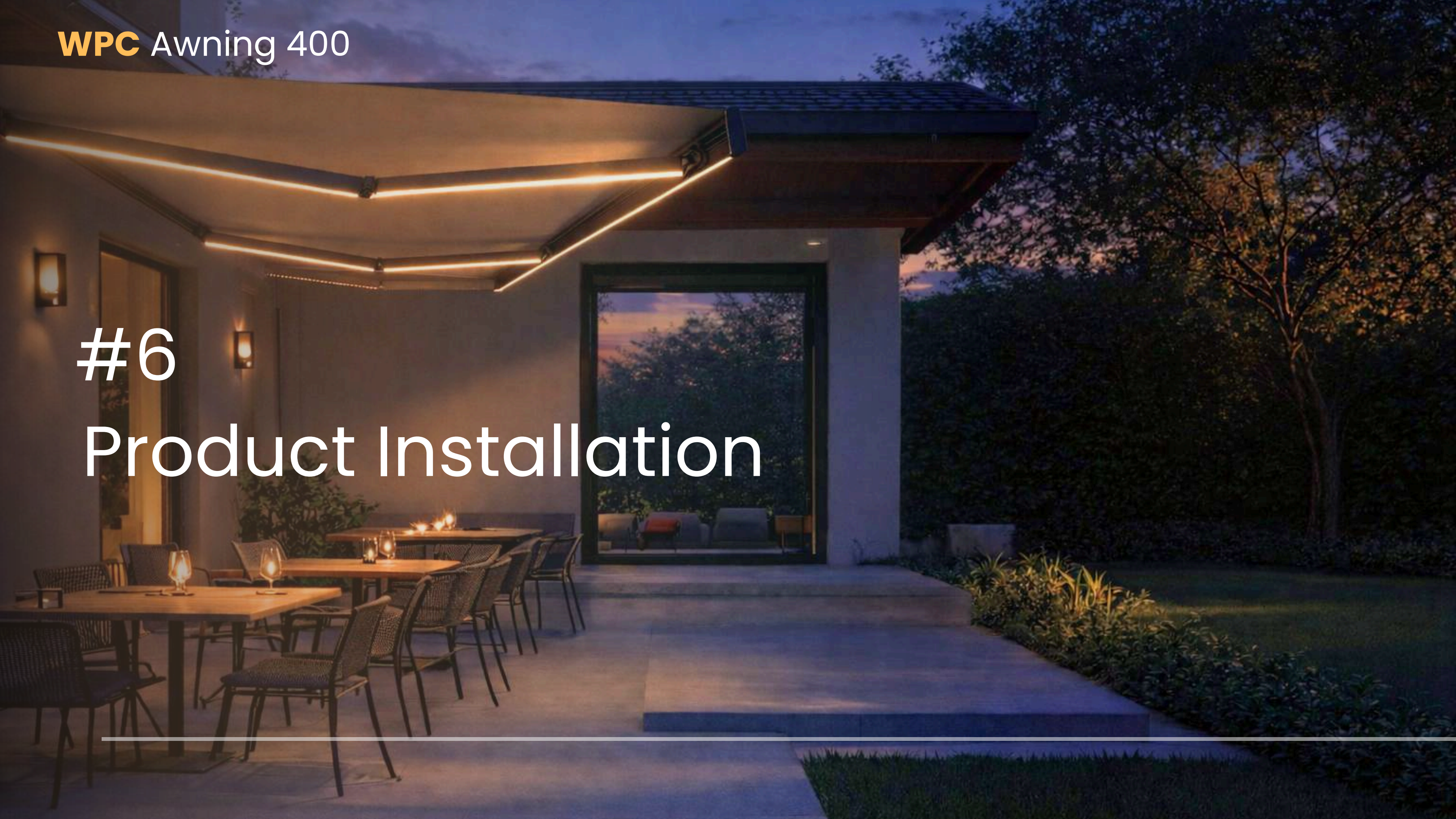

WPC Awning 400

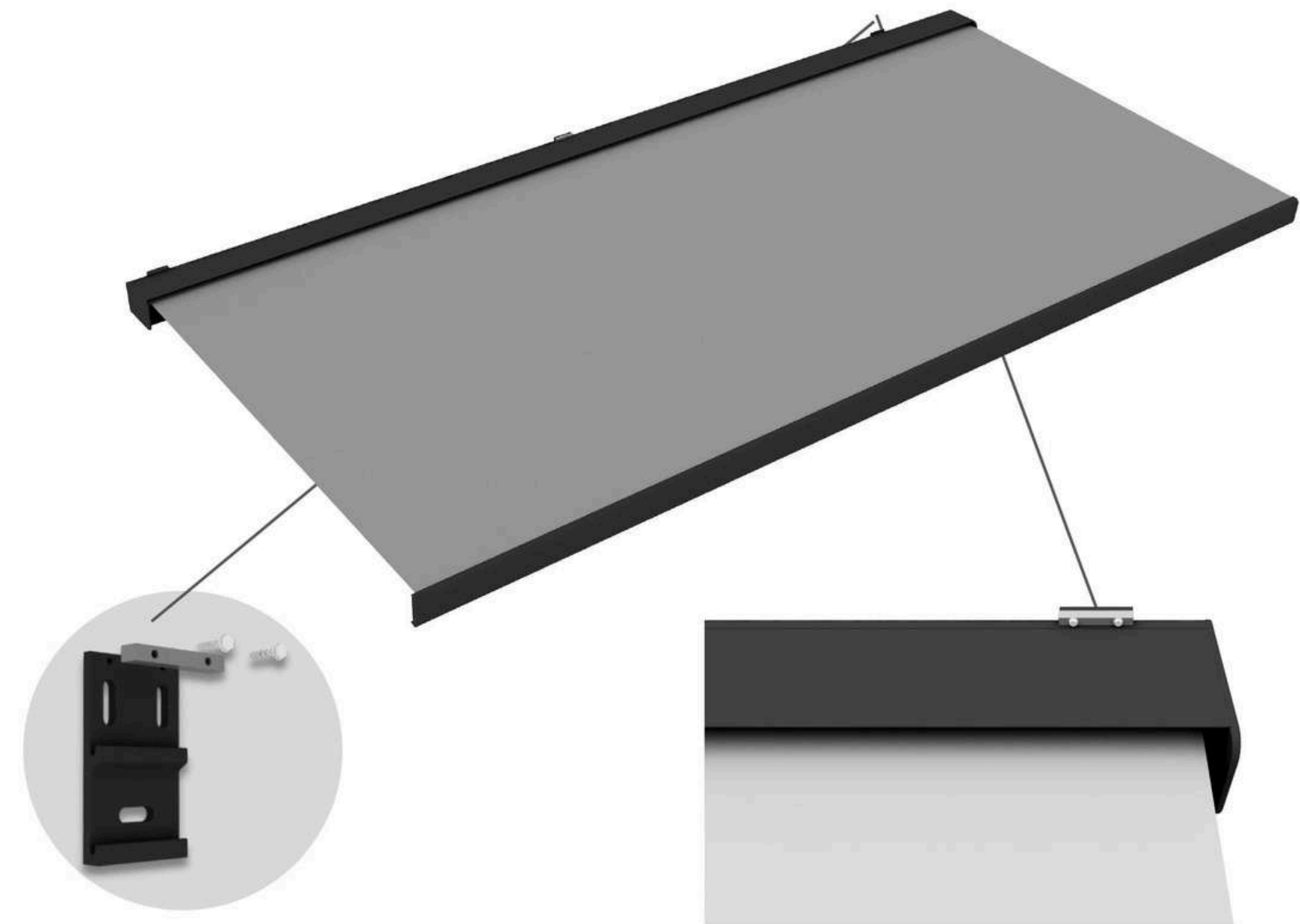

- **Wall Mounted Installation**

Use conventional wall bracket to drill holes according to the specified label position. After installing the wall bracket, clamp the product into the recessed position and then fix the anti-slip plate with fastening screws.



- **Ceiling Installation**

Use conventional fixed wall brackets and customized hanging brackets to achieve product hanging and meet installation requirements in different scenarios

WPC Awning 400



WPC Awning 400



WPC Awning 400



WPC Awning 400





WPC Awning 400

☎ +971507053444

✉ Info@wpcurtains.com

🌐 www.wpcurtain.com

UAE, Ajman, New Industrial Area, Near Lucky Roundabout, Al Ajman 7078